



MURB1620CTPbF MURB1620CT-1PbF

Ultrafast Rectifier

Features

- Ultrafast Recovery Time
- Low Forward Voltage Drop
- Low Leakage Current
- 175°C Operating Junction Temperature
- Lead-Free ("PbF" suffix)

$t_{rr} = 25ns$
$I_{F(AV)} = 16Amp$
$V_R = 200V$

Description/ Applications

International Rectifier's MUR... series are the state of the art Ultra fast recovery rectifiers specifically designed with optimized performance of forward voltage drop and ultra fast recovery time.

The planar structure and the platinum doped life time control, guarantee the best overall performance, ruggedness and reliability characteristics.



These devices are intended for use in the output rectification stage of SMPS, UPS, DC-DC converters as well as free-wheeling diode in low voltage inverters and chopper motor drives.

Their extremely optimized stored charge and low recovery current minimize the switching losses and reduce over dissipation in the switching element and snubbers.

Absolute Maximum Ratings

Parameters	Max	Units
V_{RRM} Peak Repetitive Peak Reverse Voltage	200	V
$I_{F(AV)}$ Average Rectified Forward Current	Per Leg 8.0	A
	Total Device, (Rated V_R), $T_C = 150^\circ C$ Total Device 16	
I_{FSM} Non Repetitive Peak Surge Current	Per Leg 100	
I_{FM} Peak Repetitive Forward Current	Per Leg 16	
$(Rated V_R, Square wave, 20 KHz), T_C = 150^\circ C$		
T_J, T_{STG} Operating Junction and Storage Temperatures	-65 to 175	$^\circ C$

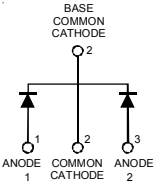
Case Styles

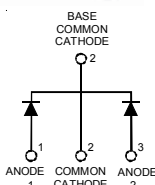
<p>MURB1620CTPbF</p>   <p>D²PAK</p>	<p>MURB1620CT-1PbF</p>   <p>TO-262</p>
--	--

Electrical Characteristics @ T_J = 25°C (unless otherwise specified)

Parameters	Min	Typ	Max	Units	Test Conditions
V _{BR} , V _r Breakdown Voltage, Blocking Voltage	200	-	-	V	I _R = 100μA
V _F Forward Voltage	-	-	0.975	V	I _F = 8A
	-	-	0.895	V	I _F = 8A, T _J = 150°C
I _R Reverse Leakage Current	-	-	5	μA	V _R = V _R Rated
	-	-	250	μA	T _J = 150°C, V _R = V _R Rated
C _T Junction Capacitance	-	25	-	pF	V _R = 200V
L _S Series Inductance	-	8.0	-	nH	Measured lead to lead 5mm from package body

Dynamic Recovery Characteristics @ T_J = 25°C (unless otherwise specified)

Parameters	Min	Typ	Max	Units	Test Conditions	
t _{rr} Reverse Recovery Time	-	-	35	ns	I _F = 1.0A, di _F /dt = 50A/μs, V _R = 30V	
	-	-	25		I _F = 0.5A, I _R = 1.0A, I _{REC} = 0.25A	
	-	20	-	A	T _J = 25°C	
	-	34	-		T _J = 125°C	
I _{RRM} Peak Recovery Current	-	1.7	-	T _J = 25°C	I _F = 8A V _R = 160V di _F /dt = 200A/μs	
	-	4.2	-	T _J = 125°C		
Q _{rr} Reverse Recovery Charge	-	23	-	nC		T _J = 25°C
	-	75	-	nC		T _J = 125°C

Thermal - Mechanical Characteristics

Parameters	Min	Typ	Max	Units
T _J Max. Junction Temperature Range	- 65	-	175	°C
T _{Stg} Max. Storage Temperature Range	- 65	-	175	
R _{thJC} Thermal Resistance, Junction to Case Per Leg	-	-	3.0	°C/W
R _{thJA} Thermal Resistance, Junction to Ambient Per Leg	-	-	50	
R _{thCS} ^① Thermal Resistance, Case to Heatsink	-	0.5	-	
Wt Weight	-	2.0	-	g
	-	0.07	-	(oz)
Mounting Torque	6.0	-	12	Kg-cm
	5.0	-	10	lbf.in
Marking Device	MURB1620CT		Case style D ² Pak	
	MURB1620CT-1		Case style TO-262	

① Mounting Surface, Flat, Smooth and Greased

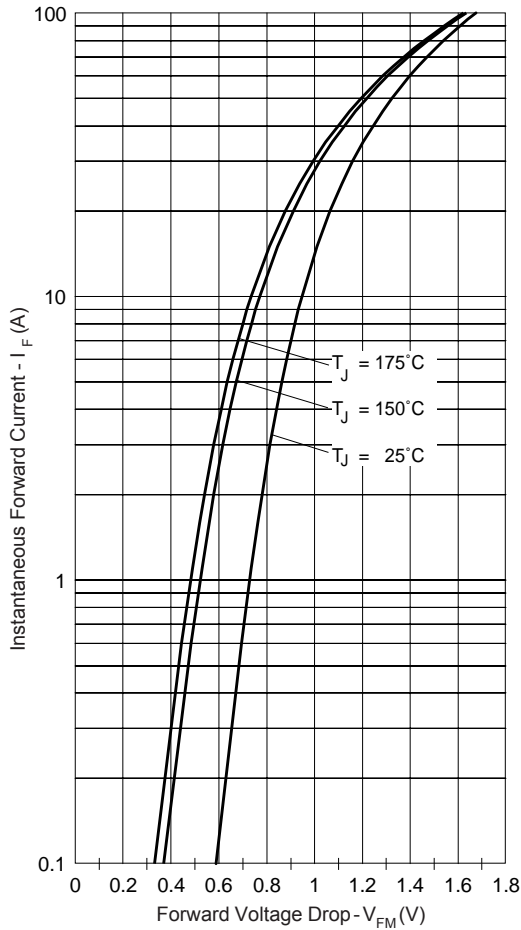

Fig. 1 - Typical Forward Voltage Drop Characteristics

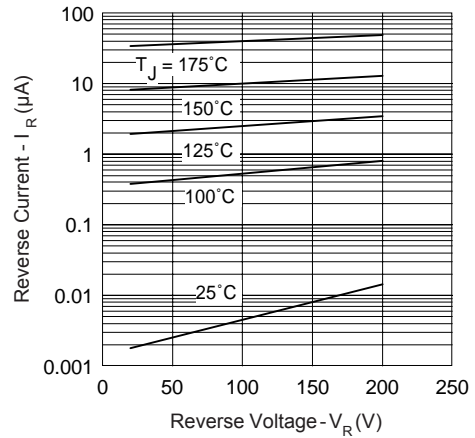

Fig. 2 - Typical Values Of Reverse Current Vs. Reverse Voltage

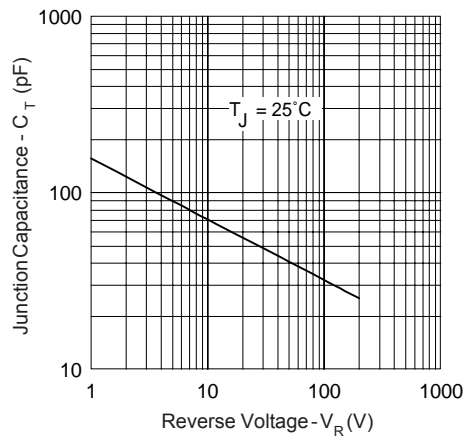

Fig. 3 - Typical Junction Capacitance Vs. Reverse Voltage

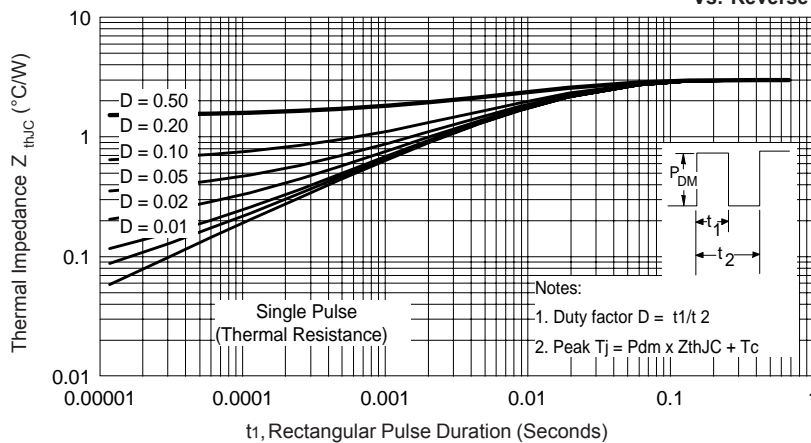

Fig. 4 - Max. Thermal Impedance Z_{thJC} Characteristics

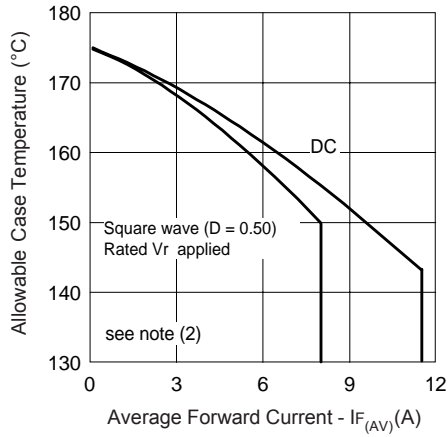

Fig. 5 - Max. Allowable Case Temperature Vs. Average Forward Current

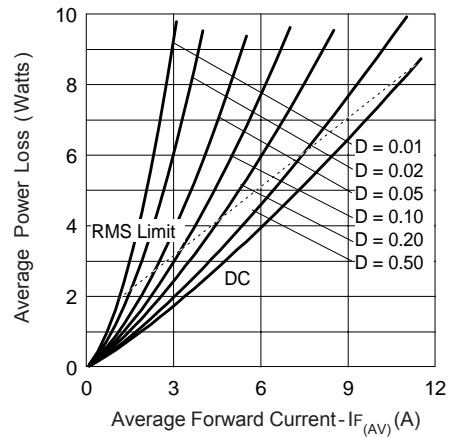

Fig. 6 - Forward Power Loss Characteristics

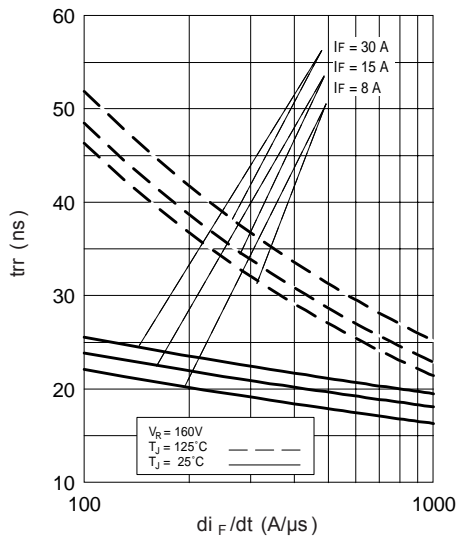

Fig. 7 - Typical Reverse Recovery vs. di_F/dt

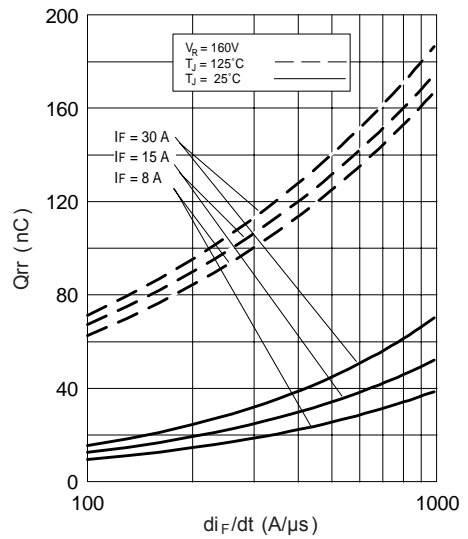

Fig. 8 - Typical Stored Charge vs. di_F/dt

(2) Formula used: $T_C = T_J - (Pd + Pd_{REV}) \times R_{thJC}$;
 $Pd = \text{Forward Power Loss} = I_{F(AV)} \times V_{FM} @ (I_{F(AV)} / D)$ (see Fig. 6);
 $Pd_{REV} = \text{Inverse Power Loss} = V_{R1} \times I_R (1 - D)$; $I_R @ V_{R1} = \text{rated } V_R$

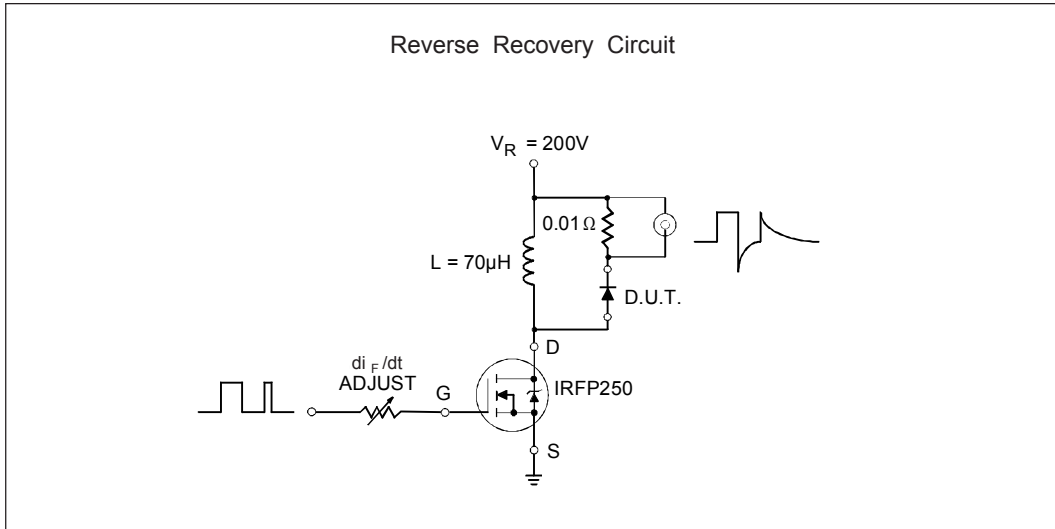

Fig. 9- Reverse Recovery Parameter Test Circuit

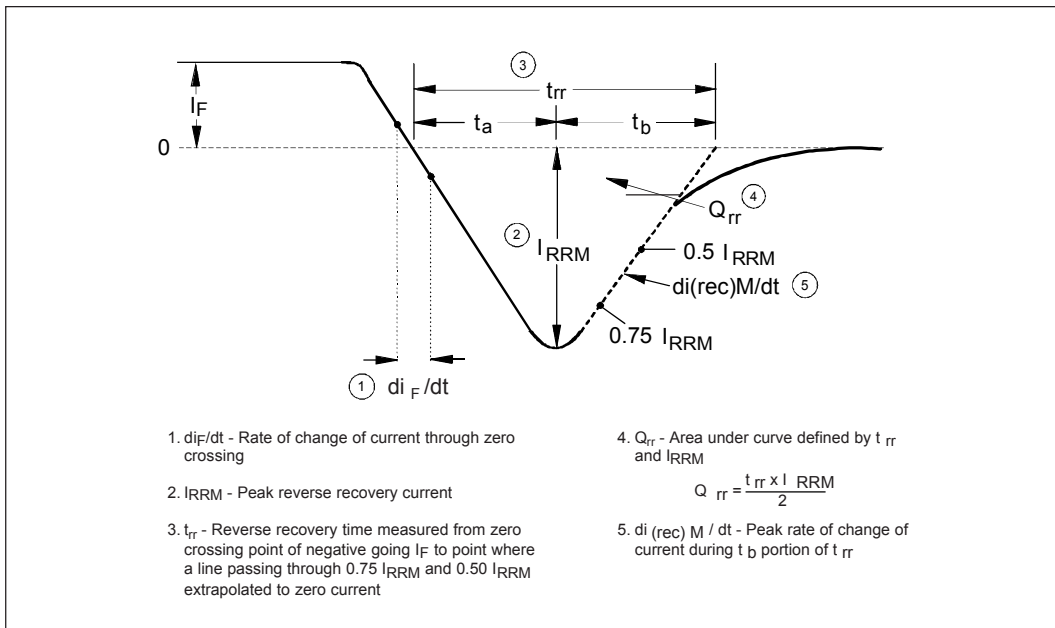
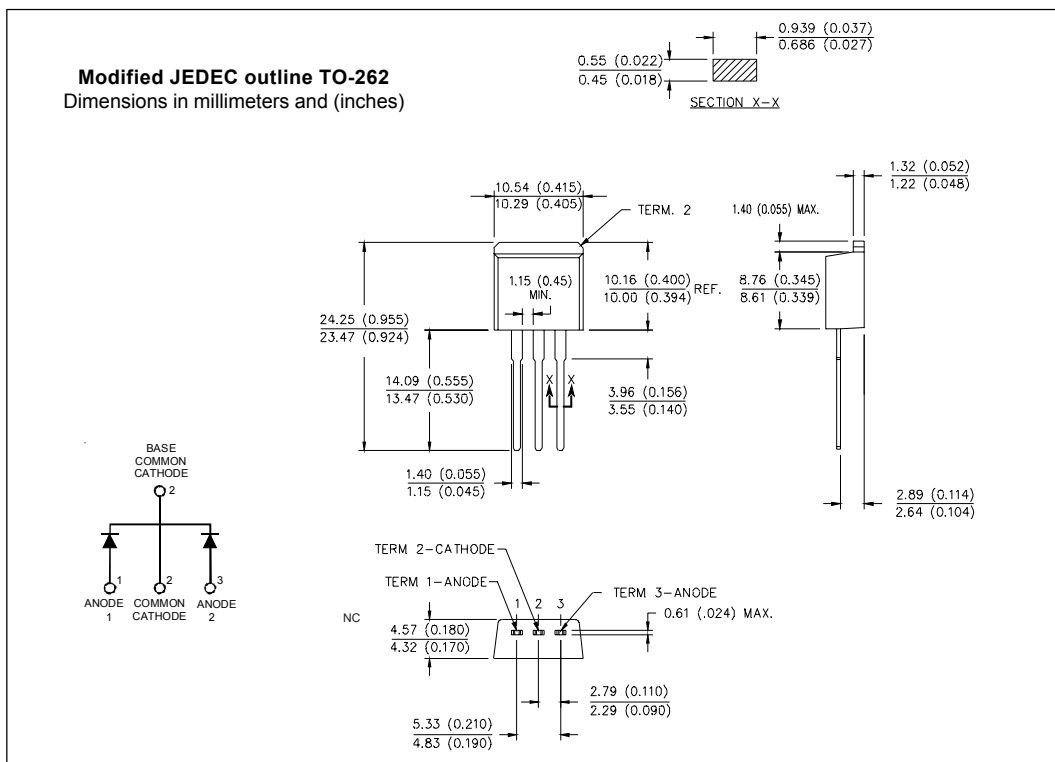
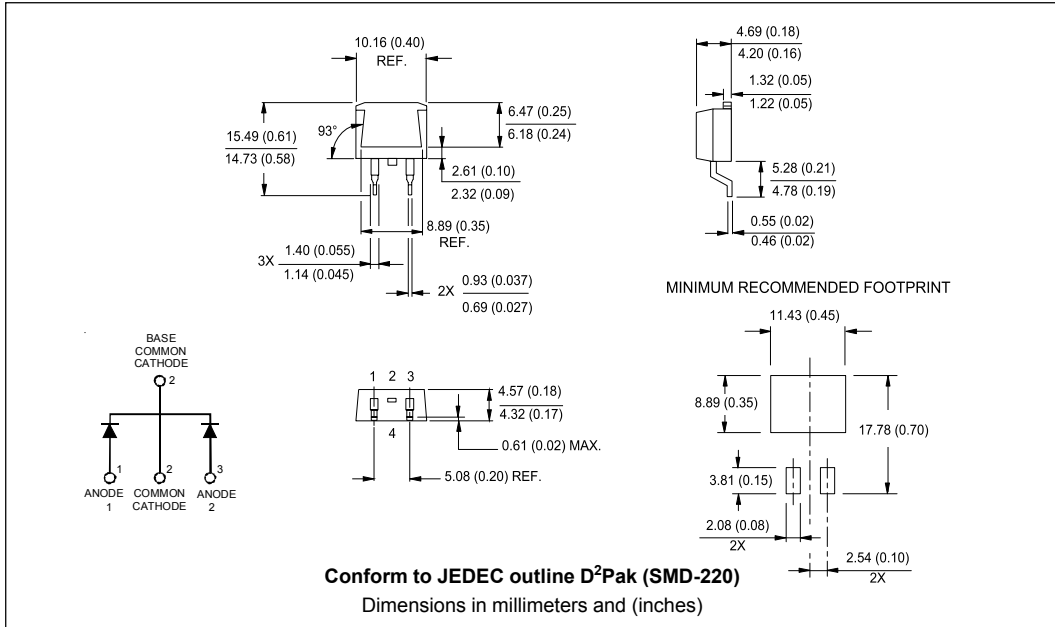

Fig. 10 - Reverse Recovery Waveform and Definitions

Outlines Table



Part Marking Information

D²PAK

EXAMPLE: THIS IS A MURB1620CT
 LOT CODE 8024
 ASSEMBLED ON WW 02, 2000

Note: "P" in assembly line position indicates "Lead-Free"

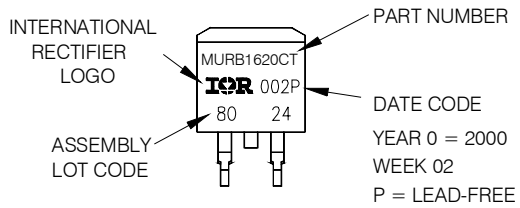

TO-262

EXAMPLE: THIS IS A MURB1620CT-1
 LOT CODE 8024
 ASSEMBLED ON WW 02, 2000

Note: "P" in assembly line position indicates "Lead-Free"

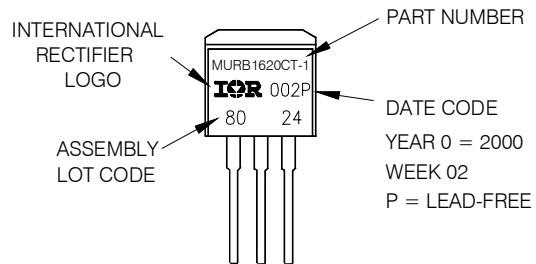

Tape & Reel Information

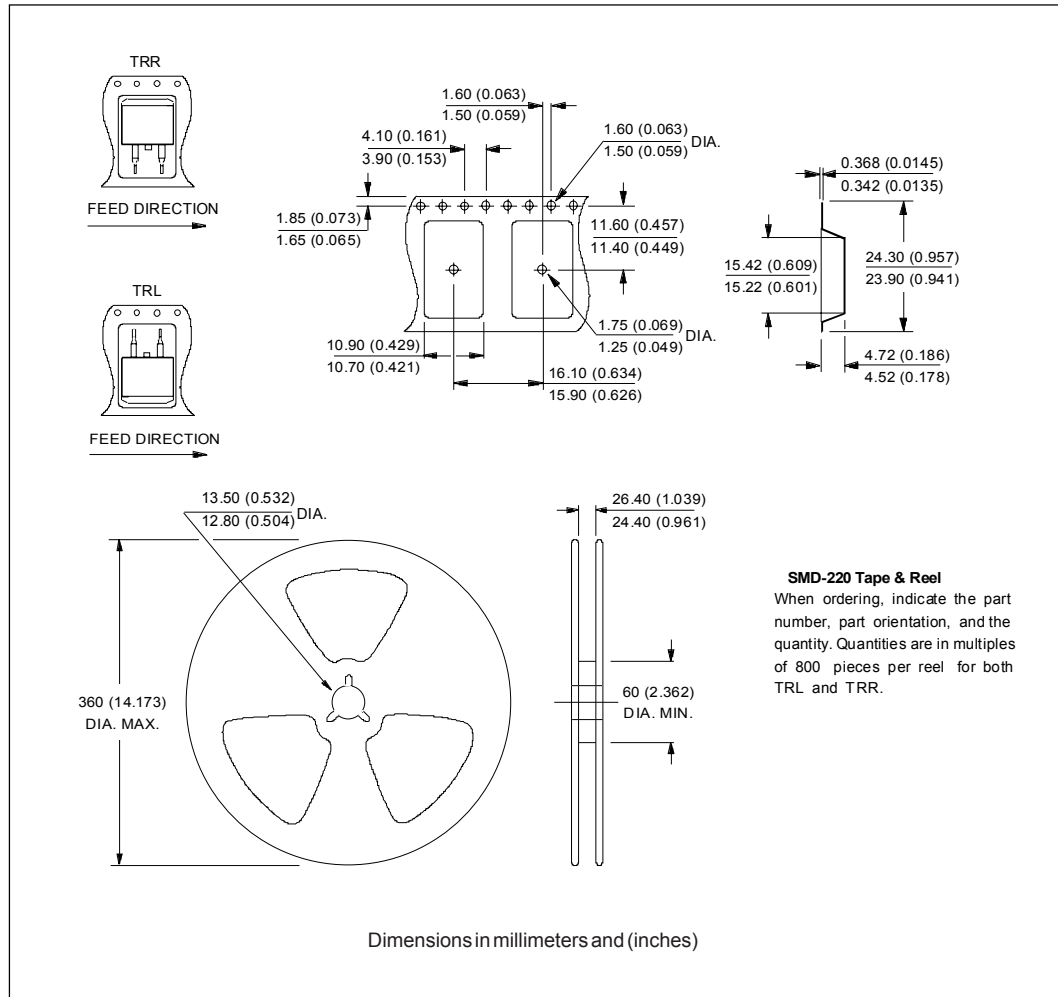

Ordering Information Table

Device Code	MUR	B	16	20	CT	-1	TRL	PbF
	①	②	③	④	⑤	⑥	⑦	⑧
1	-							
		2						
			3					
				4				
					5			
						6		
							7	
								8

1	-	Ultrafast MUR Series
2	-	B = D ² Pak/ TO-262
3	-	Current Rating (16 = 16A)
4	-	Voltage Rating (20 = 200V)
5	-	CT = Center Tap (Dual) TO-220 /D ² PAK/ TO-262
6	-	-1 = TO-262
7	-	<ul style="list-style-type: none"> • none = Tube (50 pieces) • TRL = Tape & Reel (Left Oriented, for D²PAK package) • TRR = Tape & Reel (Right Oriented, for D²PAK package)
8	-	<ul style="list-style-type: none"> • none = Standard Production • PbF = Lead-Free

Data and specifications subject to change without notice.
 This product has been designed and qualified for Industrial Level and Lead-Free.
 Qualification Standards can be found on IR's Web site.